

PWP Profiler

Seitentür - Porte latérale - Side door - Zijdeur

 PWP SA

Montage Anleitung
Instruction de montage
Building instruction
Montage handleiding



Übersicht der angelieferten Teilen.

Vue d'ensemble des pièces livrées.

View off all parts delivered.

Overzicht van alle geleverde onderdelen.

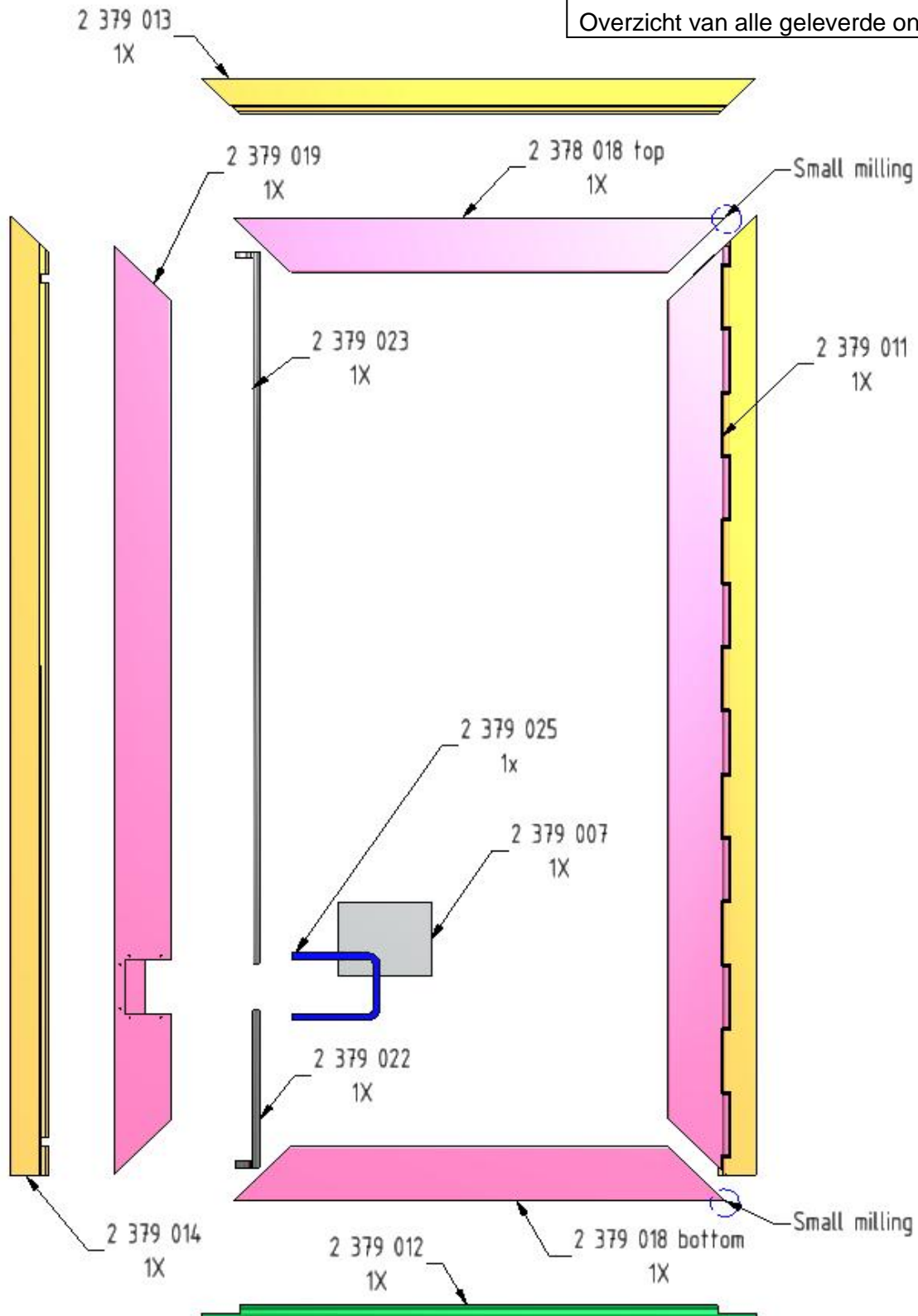

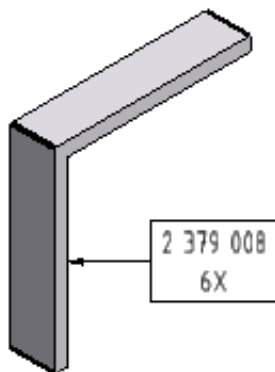
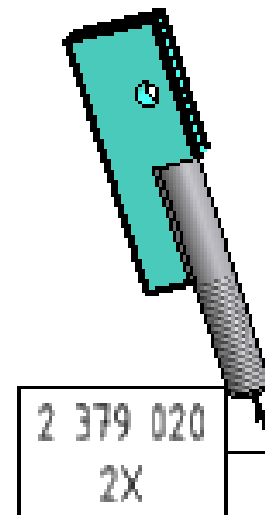
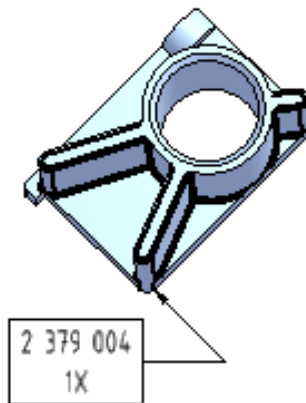
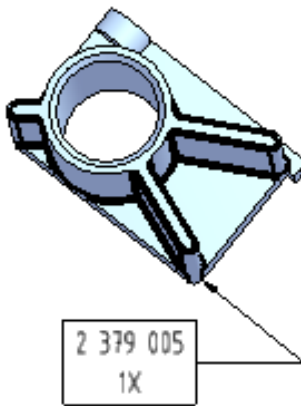
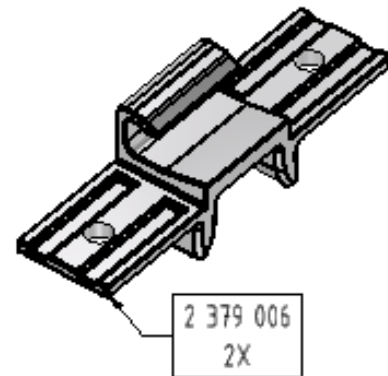
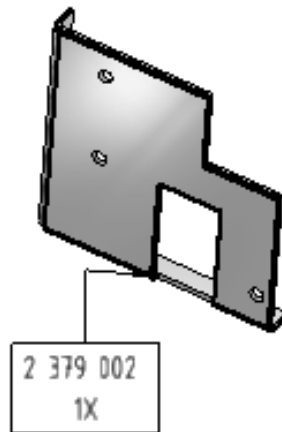
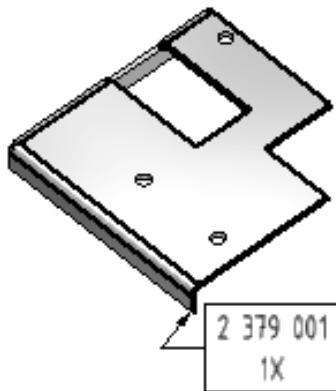

2 024 129



Montage Lagerbuchse (2x) im Türprofil.

Montage du bouchon (2x) dans le profil de porte

Fixing the bearing (2x) in the door profile

Monteren lagerbus (2x) in deurprofiel.

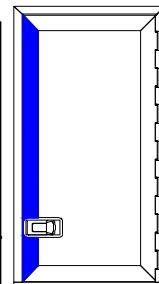

Lagerbuchse positioniert; wenn nötig verkleben.

Bouchon en place; si nécessaire le fixer avec de la colle.

Bearing in place. Fixed with glue if necessary

Lagerbus gepositioneerd. Verlijmen indien nodig.



Positionierung Verschluss im Türprofil.

Positionnement de la fermeture dans le profil de porte.

Positioning lock in door profile.

Positioneren van sluiting in deurprofiel

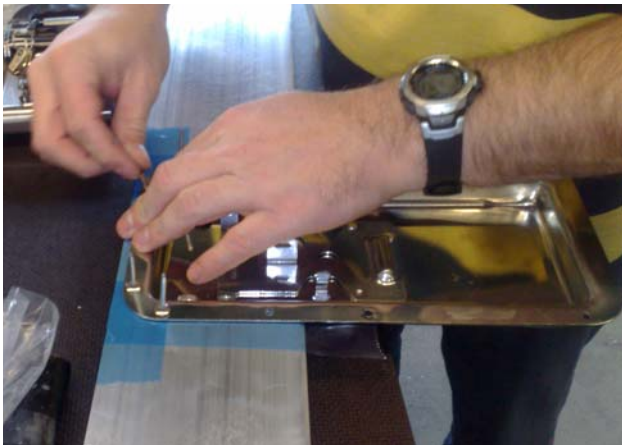

Zur Vermeidung von Kontakt-Korrosion:
zwischen Inox und Aluminium
Klebeband oder Klebemittel anbringen.

Pour éviter la corrosion de contact,
appliquer un ruban adhésif ou de la colle
entre l'inox et l'aluminium.

Preventing contact corrosion between
inox and aluminium: using tape or
glue.

Voorkomen van contact corrosie tussen
RVS en aluminium: gebruik tape of lijm.

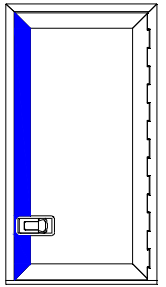

Verschluss-Stange positionieren.

Positionner la barre de fermeture.

Positioning of axle for lock.

Sluitstang positioneren.



Verschluss annieten (4 Inox-Nieten 4.8 mm)
und Handgriff montieren (nicht befestigen).

Riveter la fermeture (4 rivets Inox 4.8 mm) et
monter la poignée (sans la fixer)

Fixing the lock with 4 rivets (4.8 mm Inox)
and positioning the handle (not connecting
yet).

Vastzetten sluiting met 4 popnagels
(4.8 mm RVS) en monteren handgrip (nog
niet vastzetten).



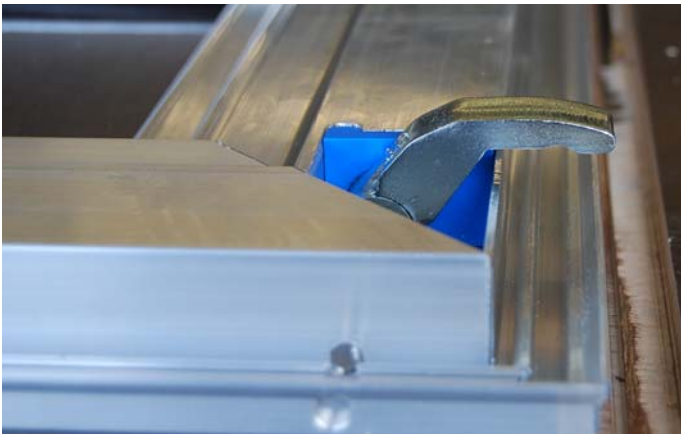
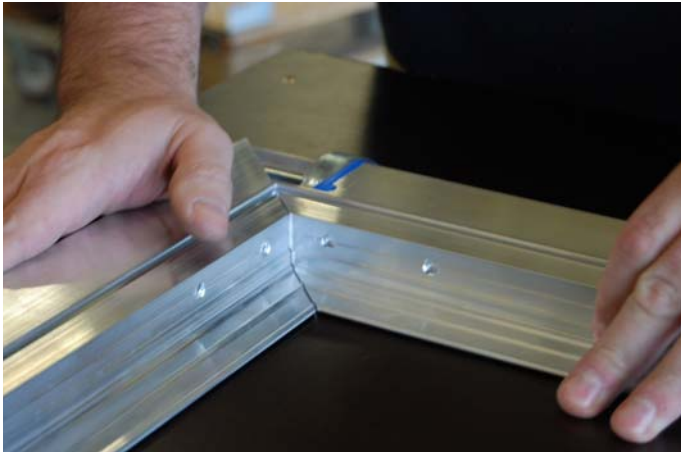
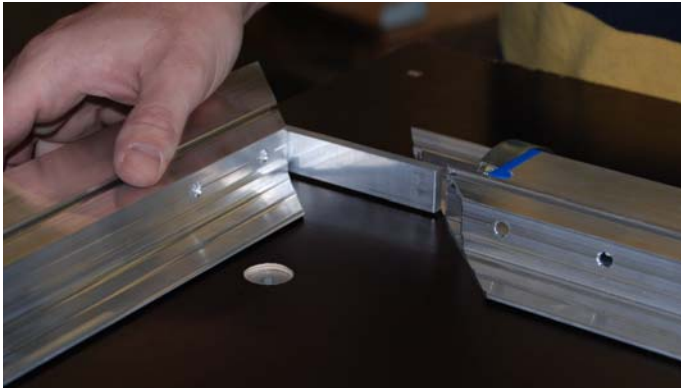

Montage Eckverbindung

Montage de la connection d'angle

Assembling corner connection

Monteren hoekverbinding

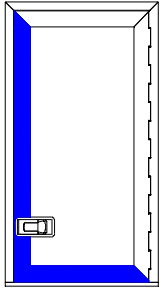

Ecken zusammen drücken.

Serrer les angles.

Press the corner in position.

Hoek goed naar elkaar toe drukken.

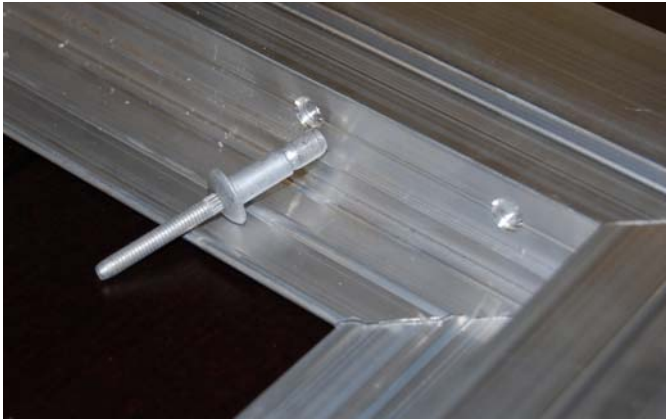

Die Löcher sind im Profil vorgebohrt.

Les avant-trous sont préperçés dans le profil.

The holes in the profile are pre-drilled.

De gaten in de profielen zijn vorgeboord.

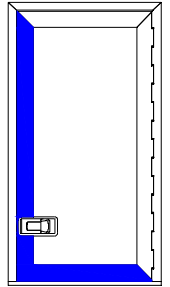

Löcher durch Eckverbindung bohren

Percer les trous dans la connexion d'angle.

Drill the holes through the corner connections

Gaten door de hoekverbinding boren.

Eckverbindung mit Monobolts befestigen.

Fixer la connexion d'angle avec des monobolts.

Fixing the corner connection with monobolts.

Hoekverbinding met monobolts vastzetten.

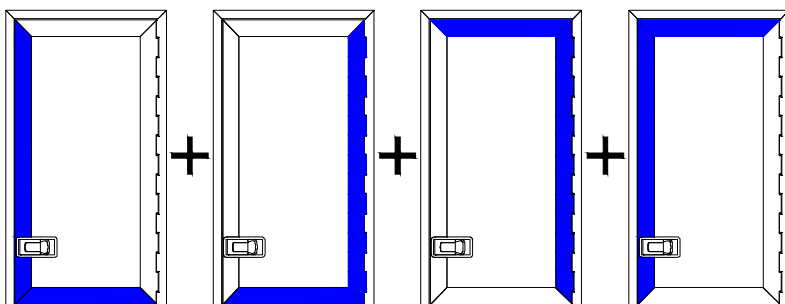
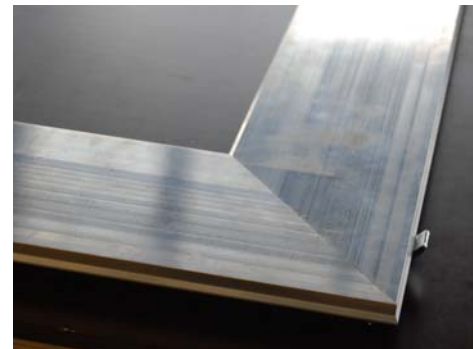
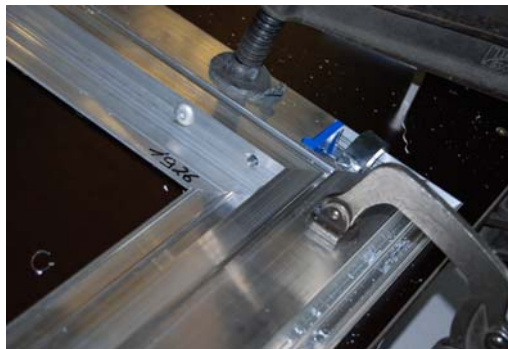
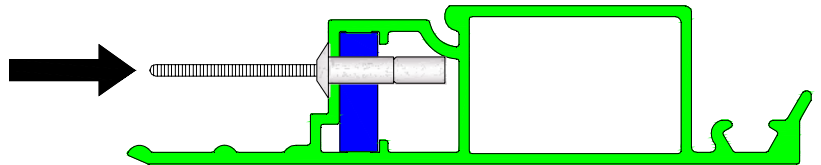

Montage aller Eckverbindungen.

Montage de toutes les connexions d'angle.

Fixing all corner connections.

Alle hoekverbinders monteren.



Verschluss-Gegenhalter (2x)
montieren und mit Klebemittel und
Nieten befestigen.

Montage des gâches de fermeture
(2x) et les fixer avec de la colle et
des rivets.

Fixing the brackets (2x) for the lock
using glue and rivets.

Sluitstuk van de sluiting (2x)
monteren met lijm en popnagels.

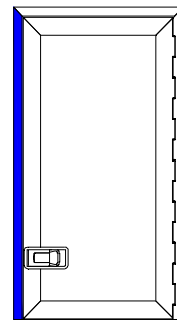

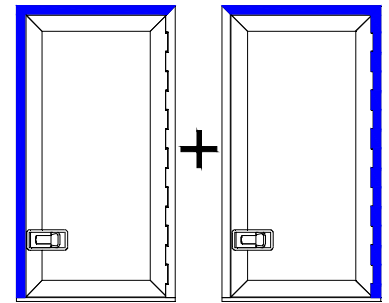
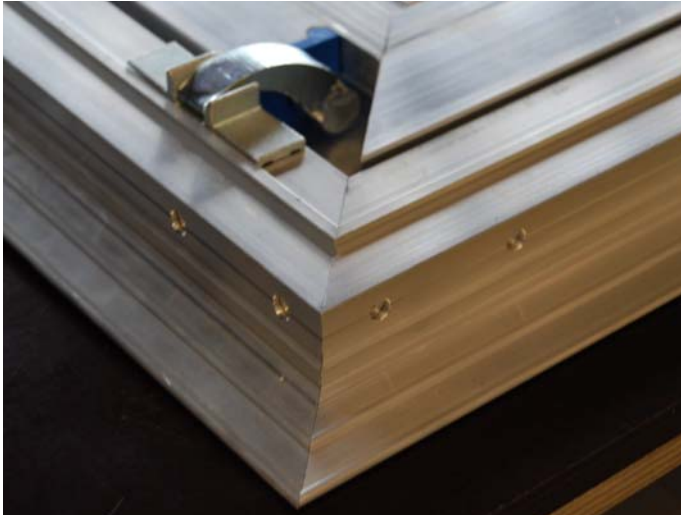

Die Löcher sind im Profil vorgebohrt.

Les avant-trous sont prépercés dans le profil.

The holes in the profiles are pre-drilled.

De gaten in de profielen zijn vorgeboord.



Löcher durch Eckverbindung bohren.

Percer les trous dans la connexion d'angle.

Drill the holes through the corner connection.

Gaten door de hoekverbinding boren.



Eckverbindung mit Monobolts montieren.

Fixer la connexion d'angle avec des monobolts.

Fixing the corner connection with monobolts.

Hoekverbinding met monobolts vastzetten.

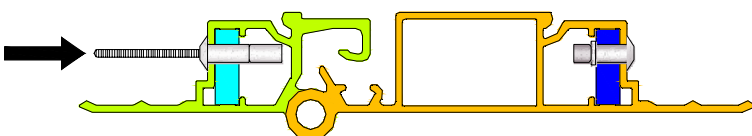

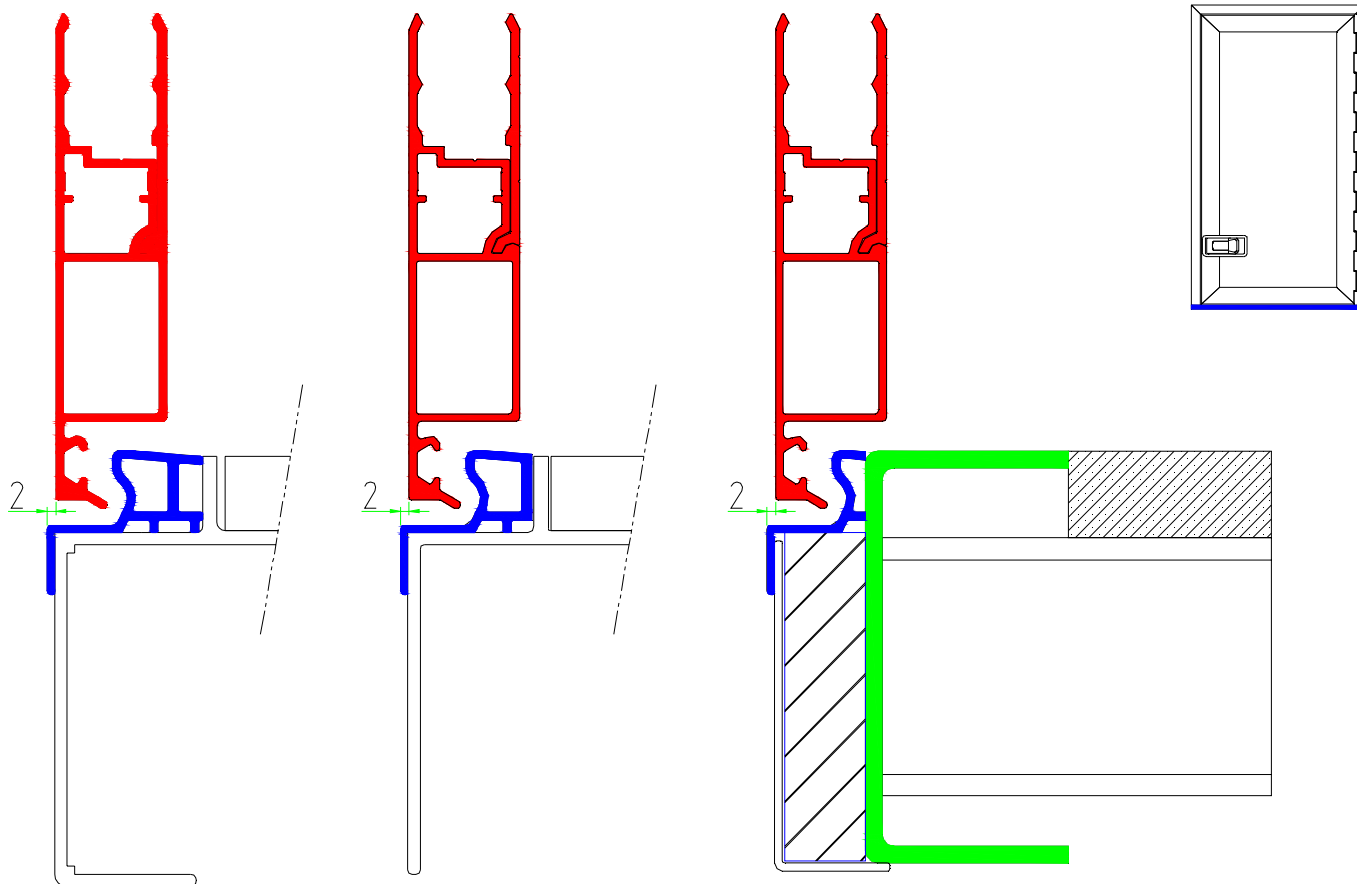

Anpassung des Schwellenprofils am Bodenrahmen.

Adaptation du profil de seuil au cadre de plancher.

Adapting the door sill profile to the subframe.

Aanpassen van het dorpelprofiel aan het grondraam.

Für die Montage des Schwellenprofils gibt es zwei Möglichkeiten:

- Vormontage direkt am Bodenrahmen (siehe Zeichnung links)
- Anschweißen an die vertikalen Kaderprofile (siehe nächste Seite)

Il existe deux manières de monter le profil de seuil:

- Prémontage direct au cadre de plancher (voir dessin de gauche)
- Soudage aux profils de cadre vertical (voir dessin ci-dessous)

For the assembly of the door sill profile there are two possibilities:

- Fixing to the subframe directly (see drawing)
- Welding the profile to the vertical frame profiles as show on the next page.

Voor het monteren van het dorpelprofiel zijn twee mogelijkheden:

- Monteren direct op het onderrandprofiel zoals in de tekening
- Vast lassen aan de verticale kader profielen zoals te zien is op de volgende bladzijde.

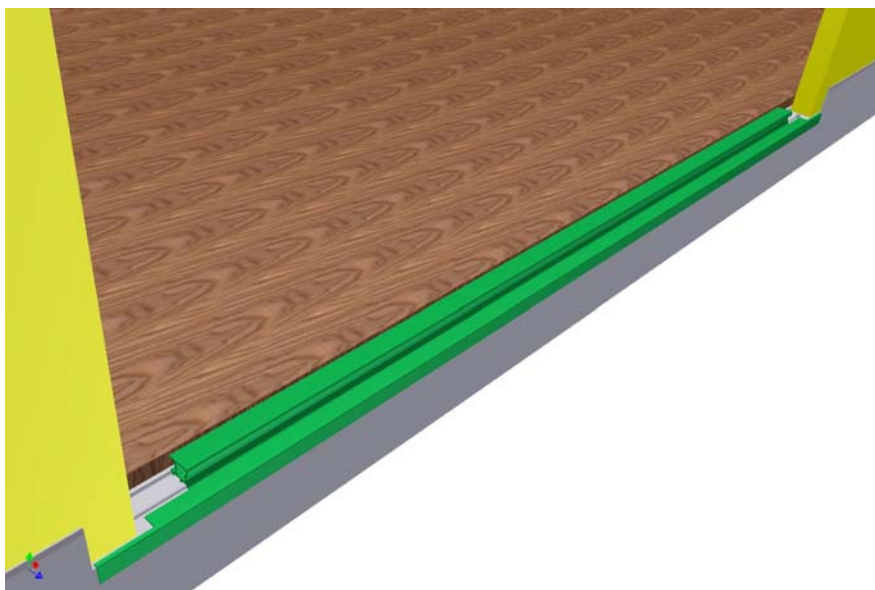

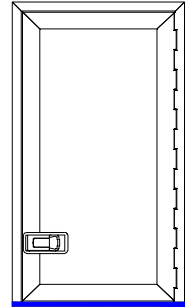
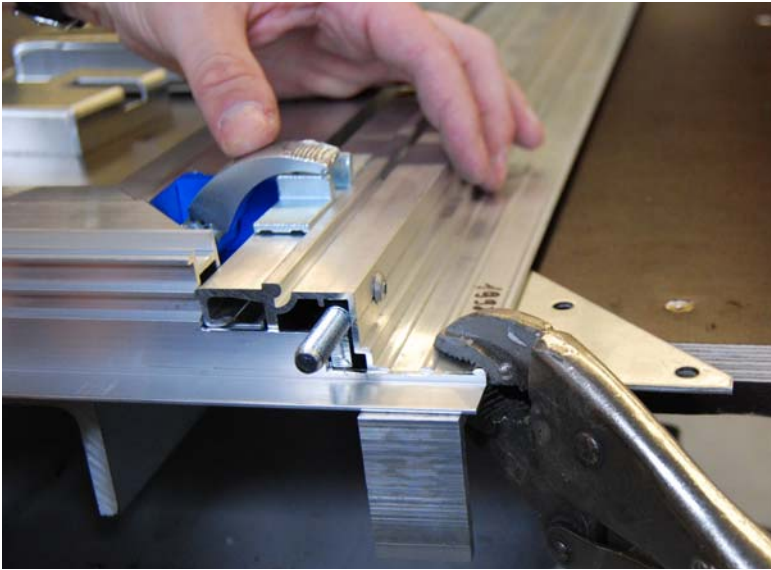

Beim Anschweißen darauf achten, dass das Schwellenprofil um 2 mm nach aussen steht.

Lors du soudage observer un dépassement du profil de seuil de 2 mm.

While welding the door sill profile make Sure it sticks out 2 mm to the outside.

Bij het lassen van het dorpelprofile opletten dat het 2 mm naar buiten toe uitsteekt.

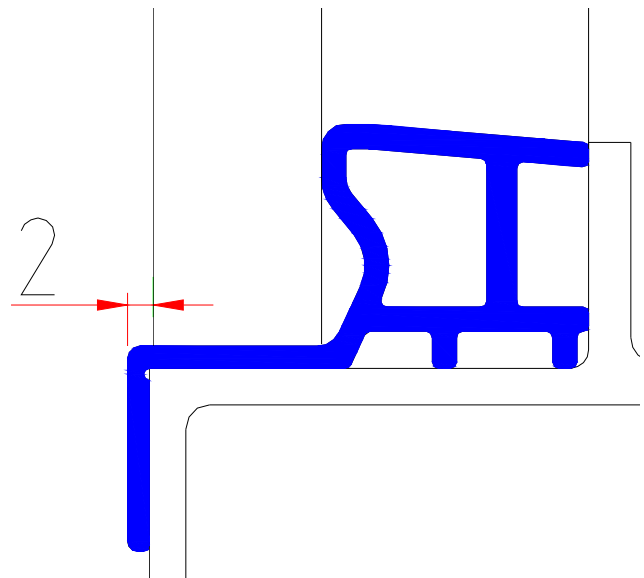

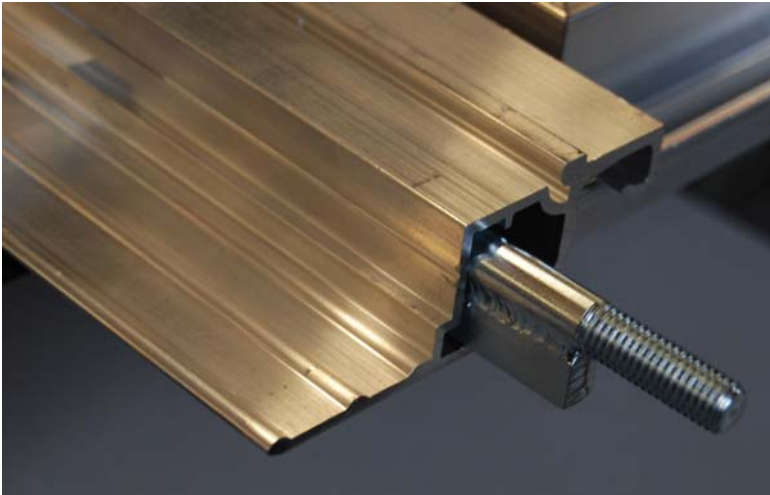

Montage Schraubteil (nicht notwendig bei starken Seitenwänden).

Montage de la pièce filletée (superflue lors de parois solides).

Fixing bolting part (not necessary with strong side walls).

Montage schroefdeel (niet nodig bij zijwand van voldoende sterkte).

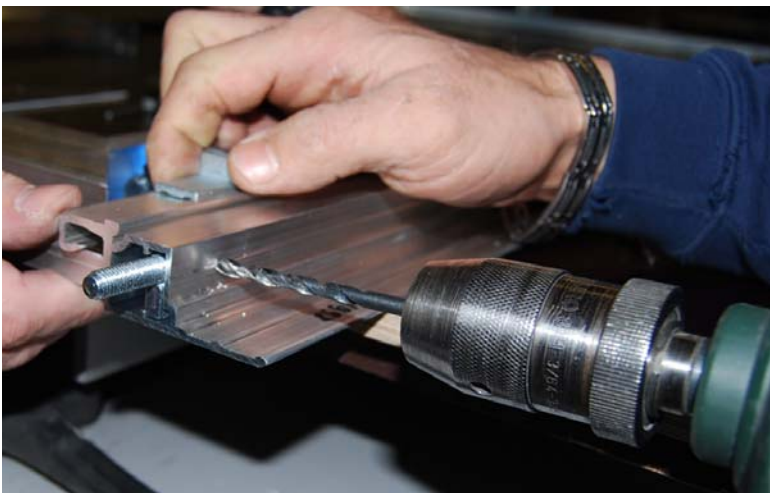
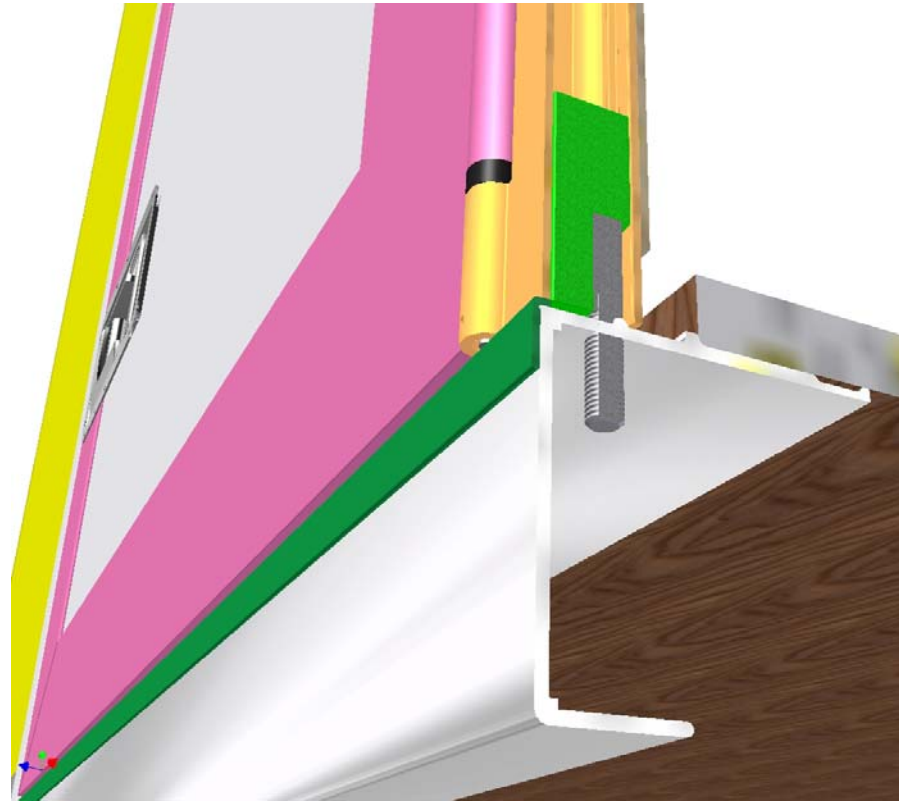

Zuschnitt Abmessungen Panel.

Dimensions de coupe des panneaux.

Cutting dimension Panel.

Zaagmaten paneel.

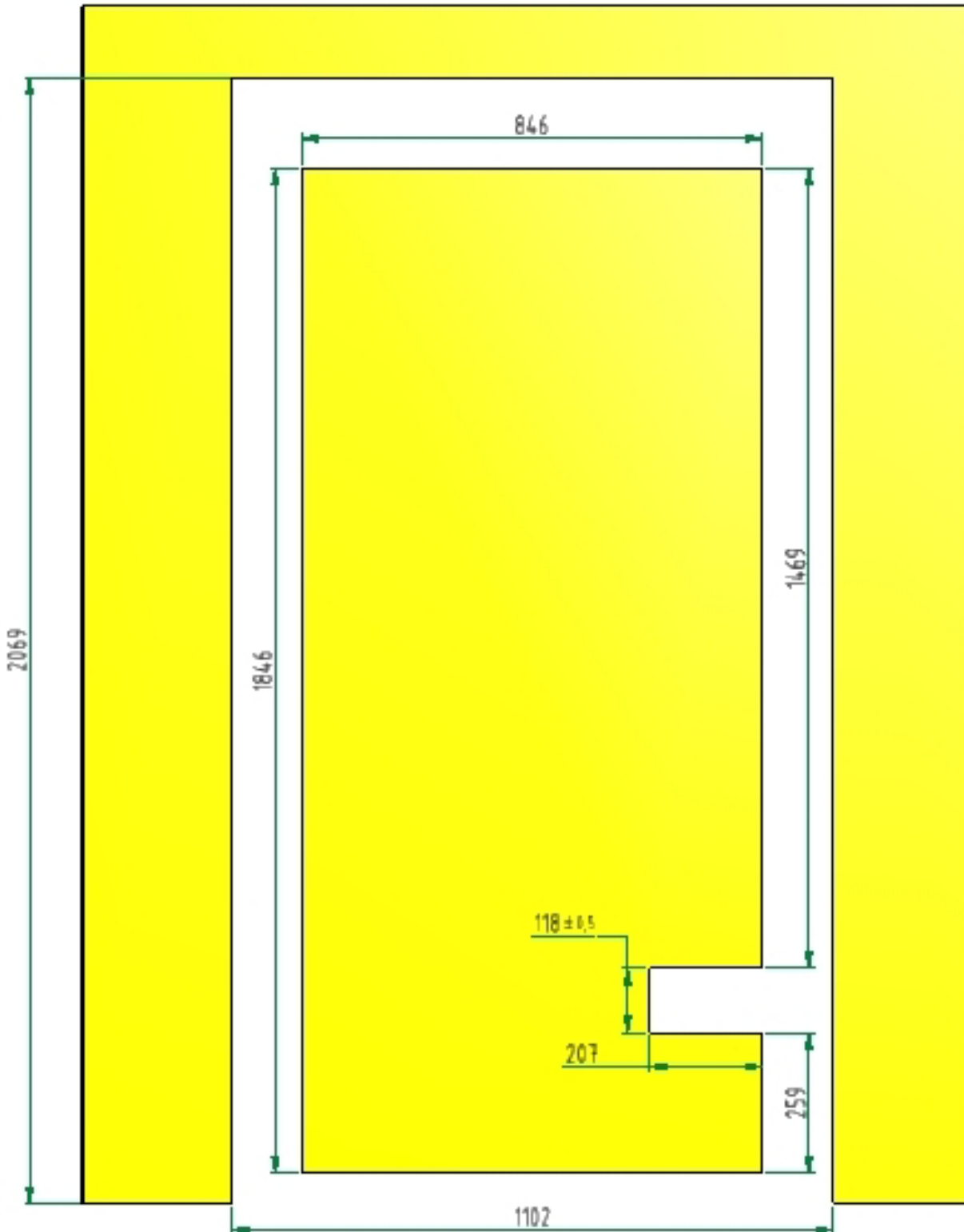
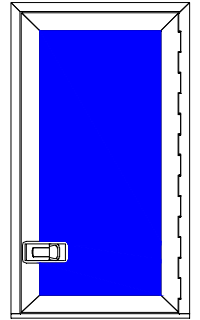

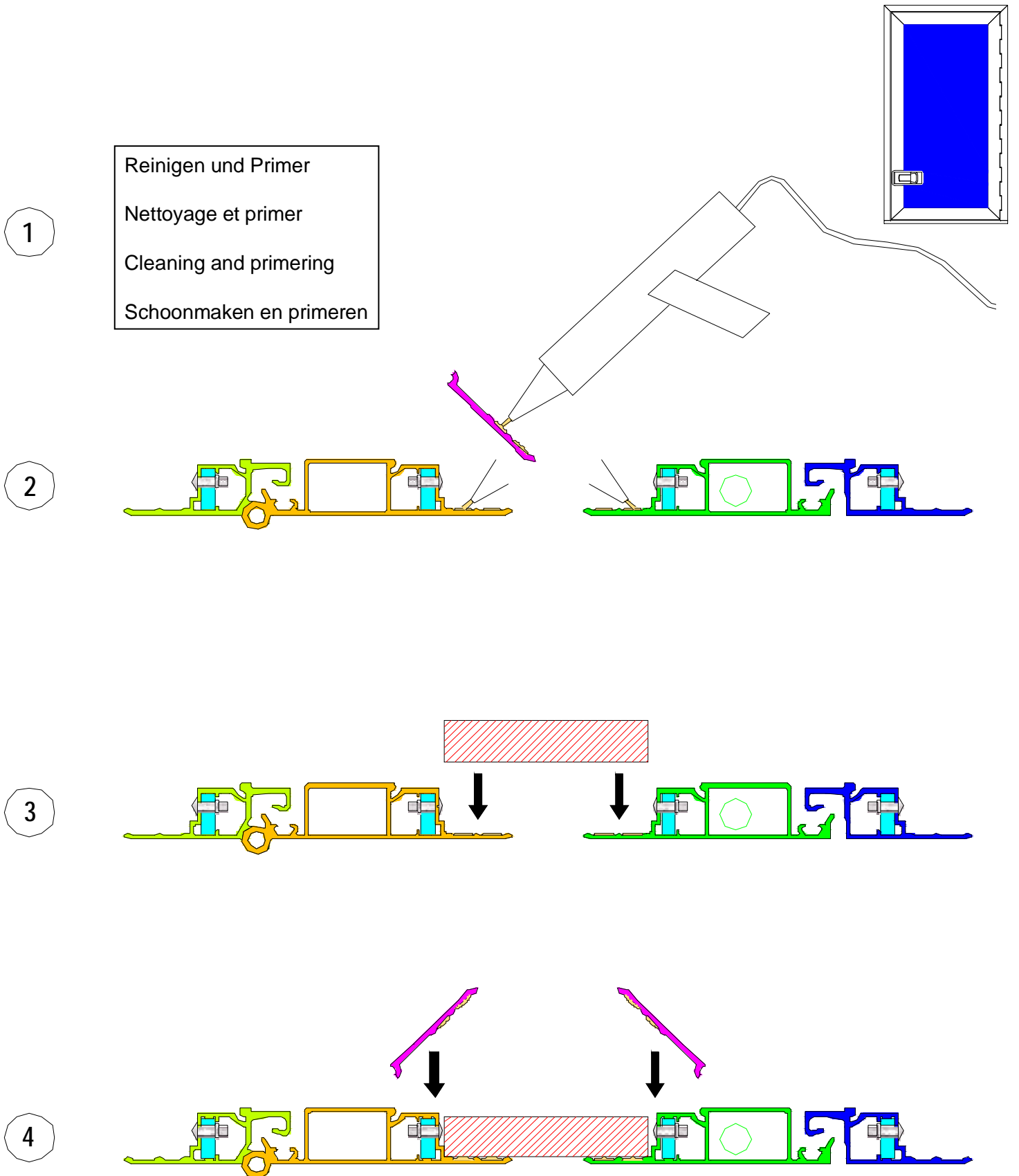

5

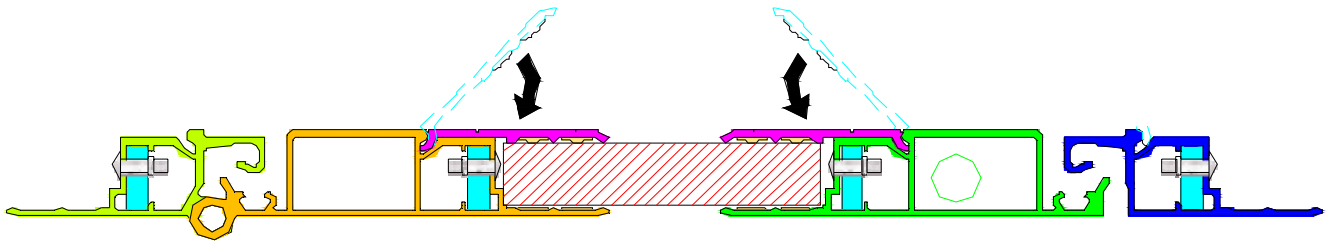

6

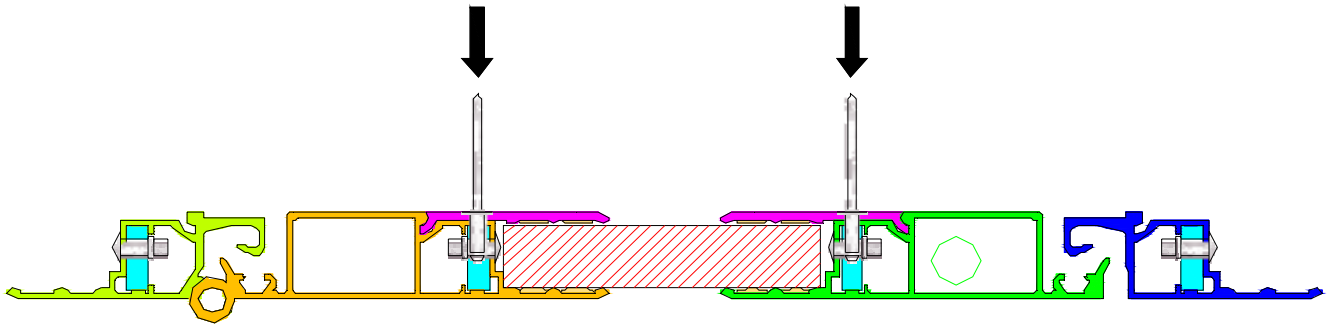

7

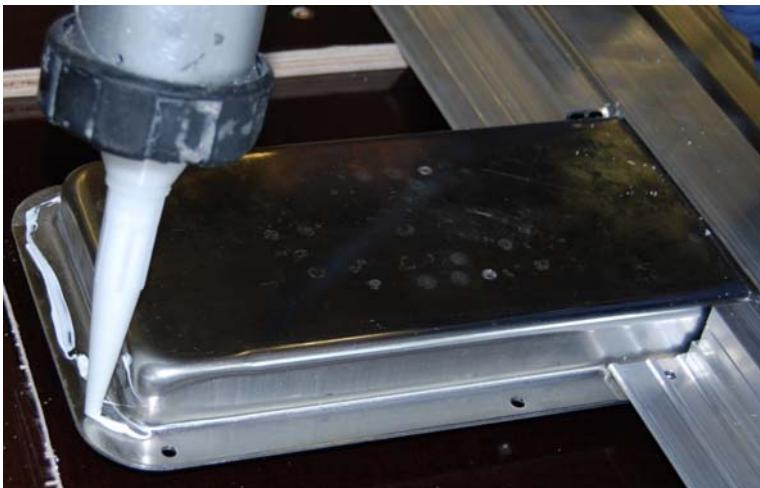
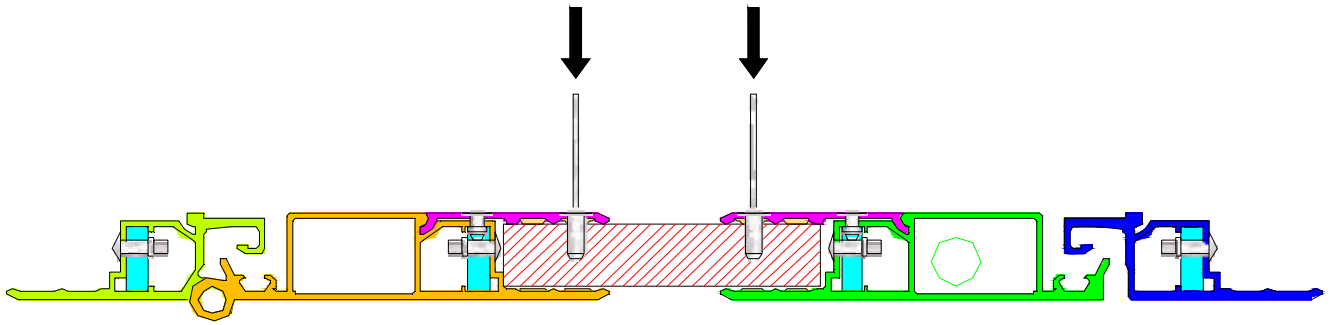

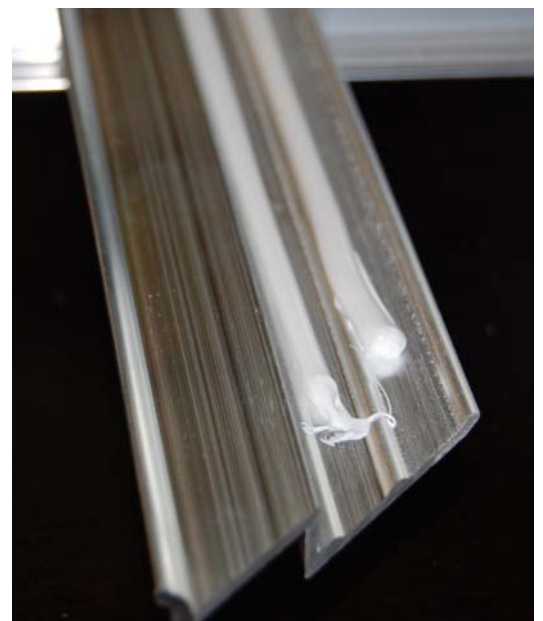
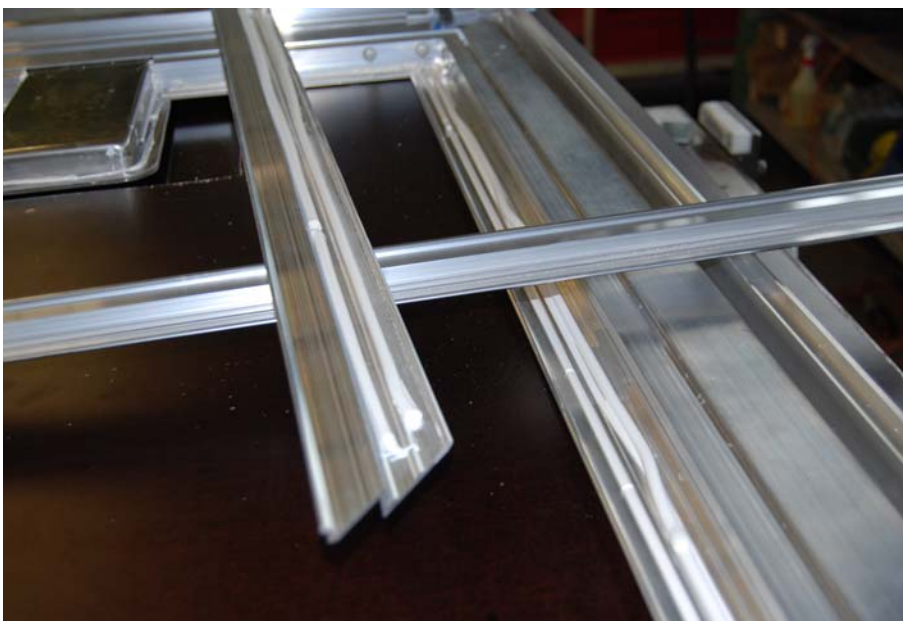
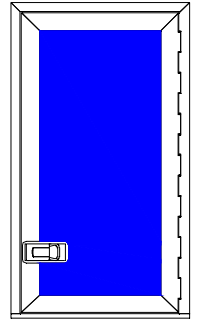

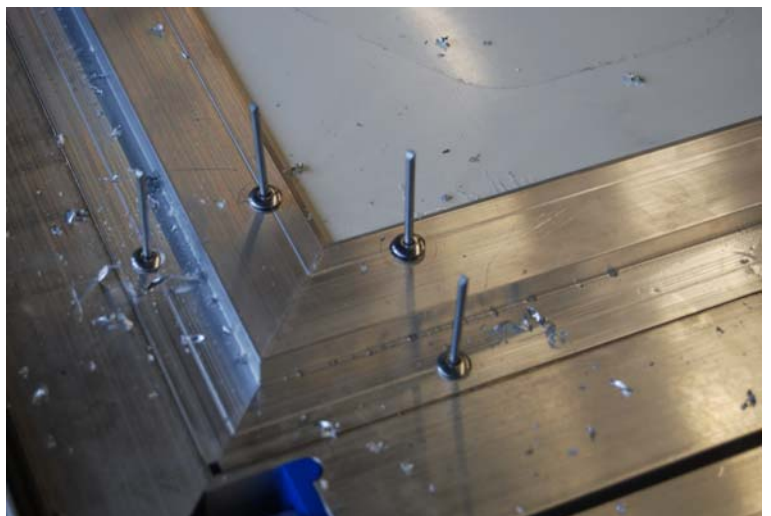
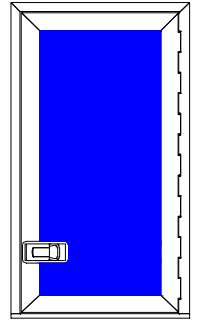
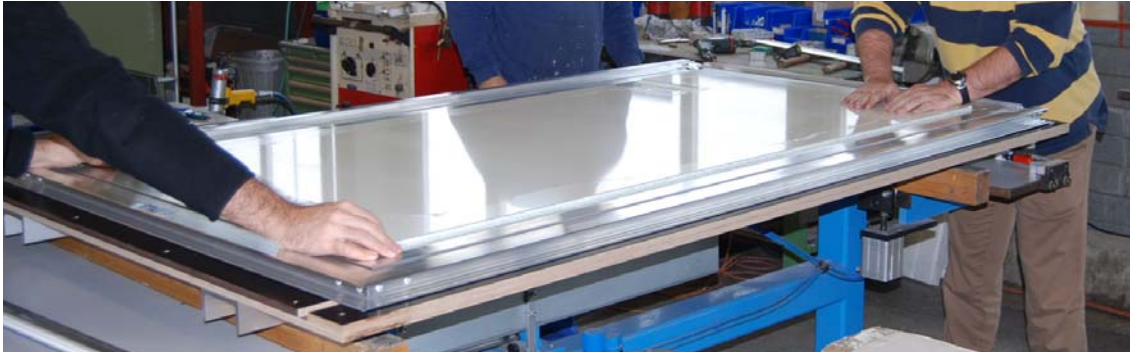

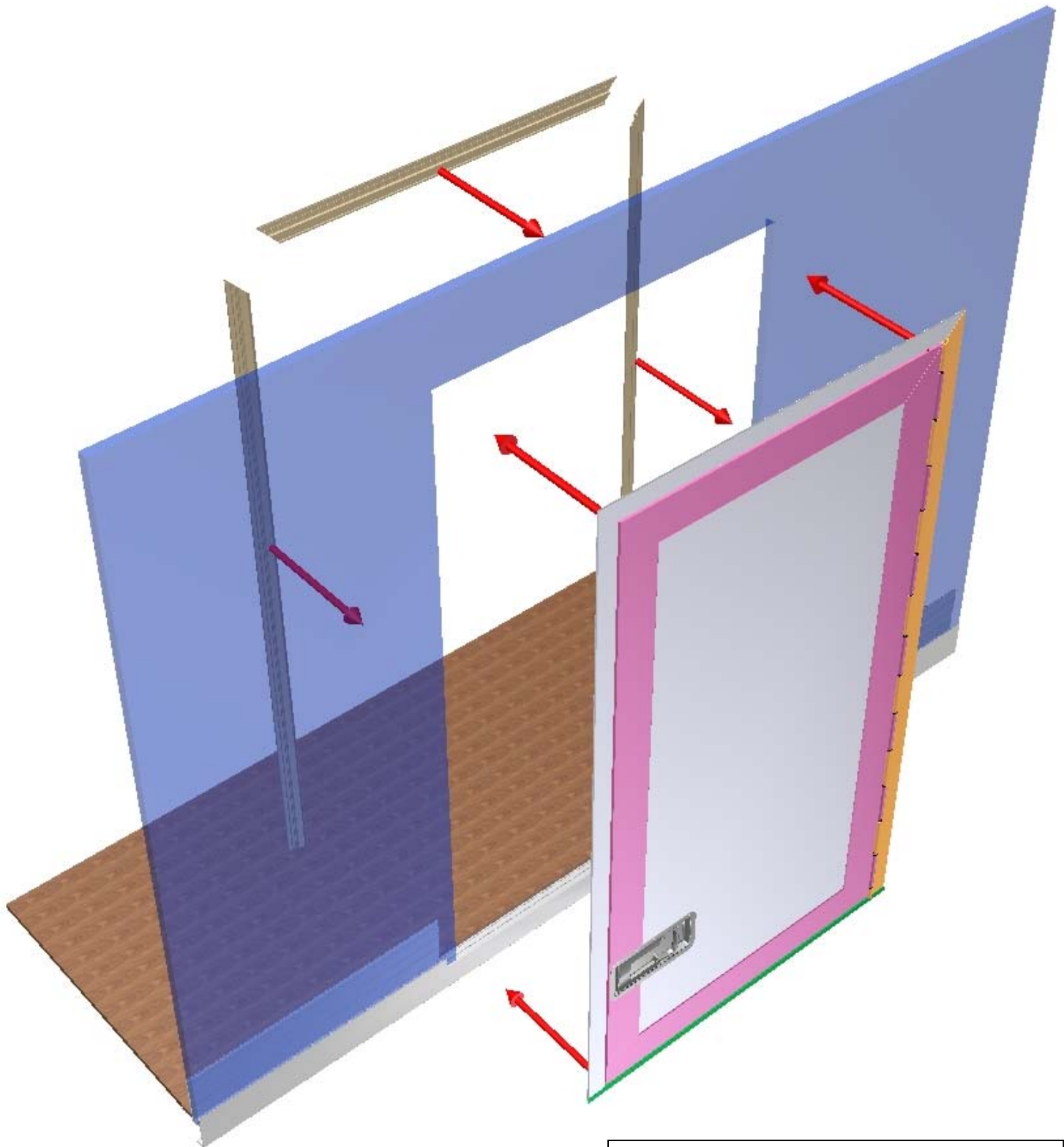

Montage Seitentür direkt in die Seitenwand.

Montage de la porte latérale directement dans la paroi latérale.

Fixing side door directly in side wall.

Montage zijdeur direct in de zijwand.

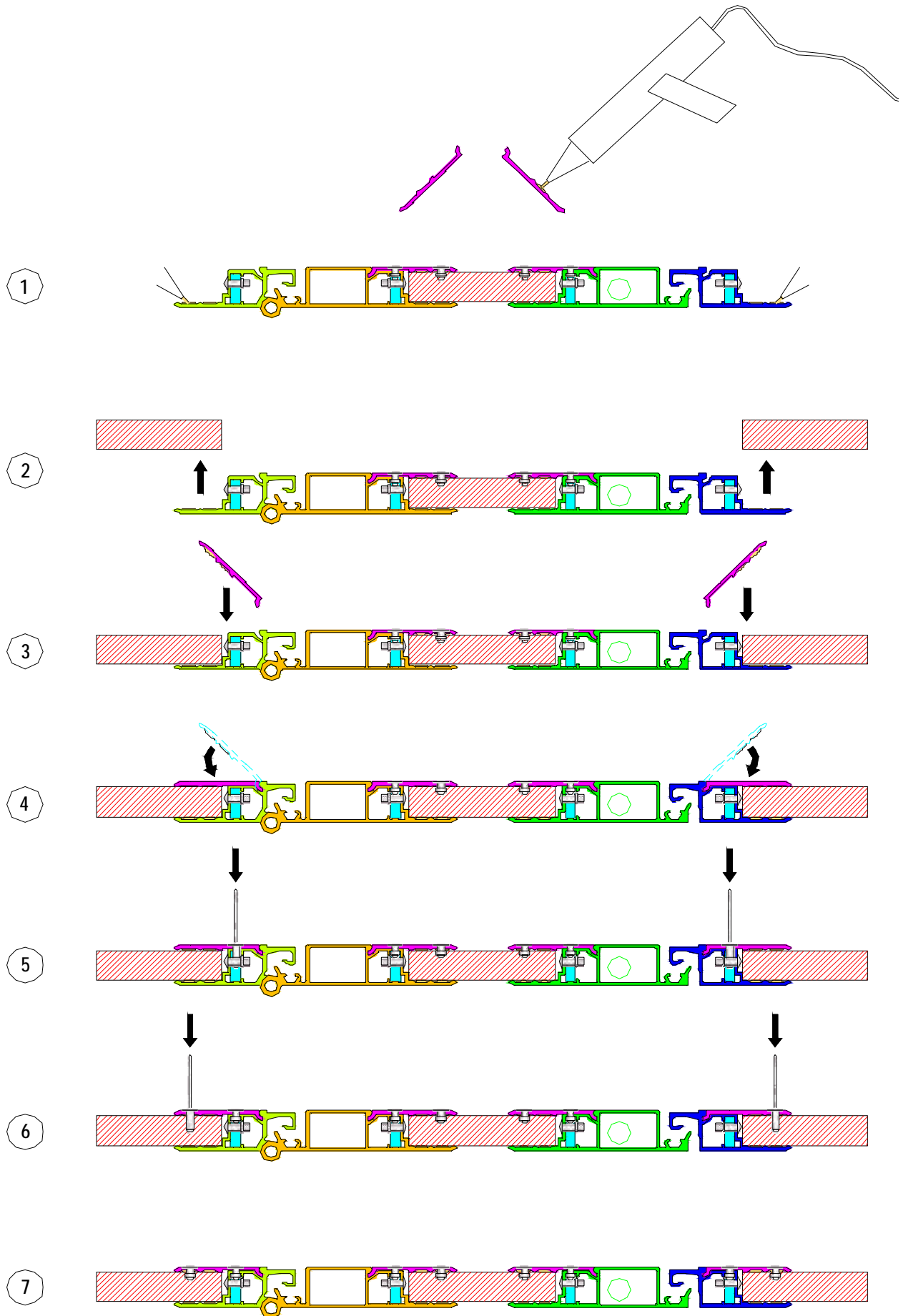



Abdeckblech mit 3 Nieten befestigen.

Fixer la tôle de recouvrement avec trois rivets.

Fixing inside cover plate with 3 rivets.

Afdekplaatje aan binnenzijde monteren met 3 popnagels.

